

DESCRIPTION

The ORPHEO wall mounted luminaire features a square profile with upward and downward light distributions, or single downward or upward light emission to create functional illumination and effect lighting scenarios. Optics include a choice of spot, narrow, medium, or wide beam spreads. Light distributions on the bi-directional models may be specified independently to achieve the desired design intent. Premium class LEDs in RGBW with 4000K natural white deliver the widest range of warm white shades and pastel tones assortment. White light sources may be dynamic from 2700K to 6500K, or static warm, neutral, or cool white. Integral driver with universal 120v to 277v input combined with on-board controls programmed by an infra-red hand-held remote deliver simple cost-effective solutions for simple stand-alone or synchronized luminaire sequencing. The luminaire may also interface with external DMX control systems for sophisticated lighting scenes.



FEATURES

- Available in RGBW, dynamic white, or static white
- Single or bi-directional optical configurations
- Four light distributions
- Standalone programming or interface with DMX
- Suitable for use indoors or outdoors
- Four standard finishes or custom RAL finish

IP66 / IK10 / CE / 

Date: _____ Type: _____ Catalog Number: _____

Project Name: _____

ORDERING INFORMATION

LUMINAIRE								
MODEL	CCT	CONTROL	CABLE	VOLTAGE	OPTICS ONE*	OPTICS TWO*	FINISH	OPTIONS
OR150S ORPHEO Wall Luminaire	RGBW30K RGBW (3000K White)	DMX-RDM DMX/RDM	S Power in, DMX in, DMX out	UNV 120-277V	SP Spot 6°	SP Spot 6°	AG Anthracite Gray	AST Anti Saline Treatment
	RGBW40K RGBW (4000K White)				NB Narrow 18°	NB Narrow 18°	BL Black	
	DW Dynamic White (2700K-6500K White)				MB Medium 26°	MB Medium 26°	SG Griven Silver Grey	
	27K 2700K				WB Wide 45°	WB Wide 45°	WH White	
	30K 3000K					NA[§] Not Available	CC Custom RAL Color	
40K 4000K								

* Contact factory for availability of spreading diffusers

§ Select NA if ordering single emission luminaire only

Note: Orient optics up or down as desired.

PRODUCT SPECIFICATIONS

Housing	Extruded aluminum body with die-cast lens rings
Mounting	Wall mount for installation onto 4" diameter outlet box with 3.45" screw spacing or 3" x 4" rectangular outlet box with 3.281" screw spacing
Optics	Spot 6°, Narrow 18°, Medium 26°, Wide 45° (Light distributions for up and down models may be mixed or matched)
Color	RGBW in 4000K White, Dynamic White in 2700K-6500K, or Static White in 3000K, 4000K, or 6500K.
Lumen Output	RGBW: up to 786 lms per source Dynamic white: up to 1201 lms per source 6500K white: up to 1407 lms per source 4000K white: up to 1320 lms per source 3000K white: up to 995 lms per source
Power Consumption	Single source: 0.18A @ 120VAC / 0.09A @ 277VAC / 20.5 watts maximum Dual source: 0.35A @ 120VAC / 0.17A @ 277VAC / 41 watts maximum
Efficacy	RGBW: up to 38 lm/W / Dynamic White: up to 59 lm/W / Neutral White (4000K): up to 64 lm/W
Lumen Maintenance	100,000 hours L70 @ 25°C
Operating Temperature	-30°C to 50°C (-22°F to 122°F)
Weight	Single source: 8.5lbs / Dual source: 9.4 lbs
Certification	IK10 / CE / ETL
Ingress Protection	Wet Location IP66 Rated
Control	DMX-RDM, Auto Control standalone onboard sequencing, or master-satellite operation. Unless an RDM control is used, ORPHEO must always be purchased with one AL2660 WeeZerd1 to set its DMX address.
Additional Features	Automatic overtemperature protection / IR Remote / Self-resetting fuse

DIMENSIONS

All dimensions are shown in inches unless otherwise noted.

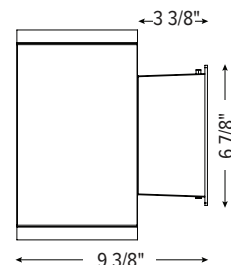
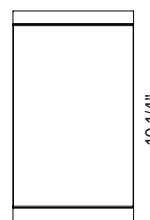
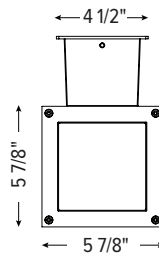
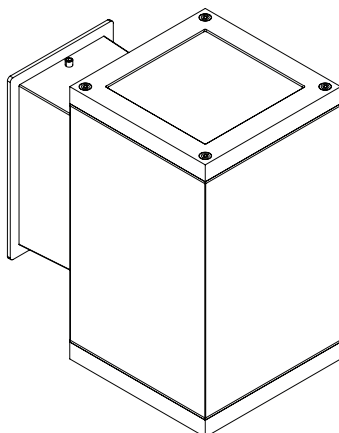

PHOTOMETRICS

RGBW

Spot 6° Maximum Candela 51319.81

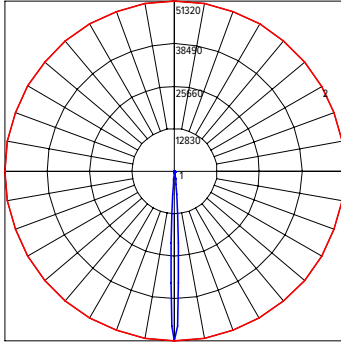

Narrow Beam 18° Maximum Candela 4572.67

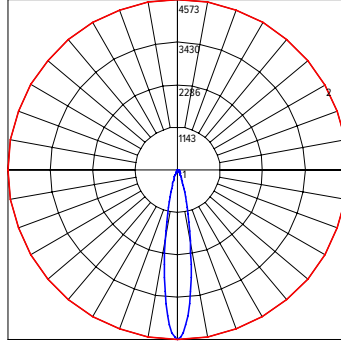

Medium Beam 26° Maximum Candela 3237.48

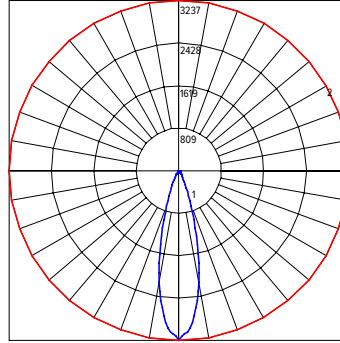

Wide Beam 45° Maximum Candela 1743.44

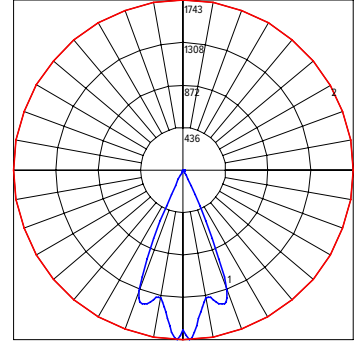

DYNAMIC WHITE

Spot 6° Maximum Candela 78413.90

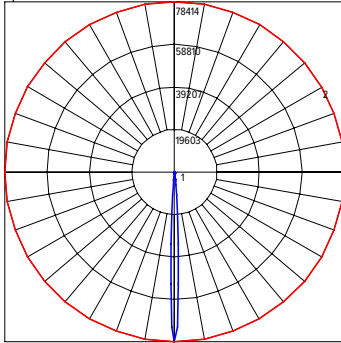

Narrow Beam 18° Maximum Candela 6986.79

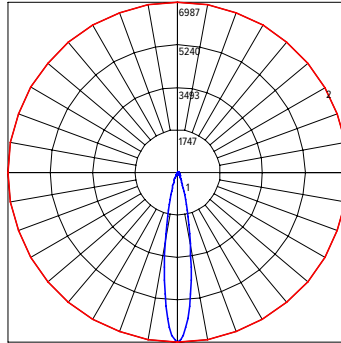

Medium Beam 26° Maximum Candela 4946.69

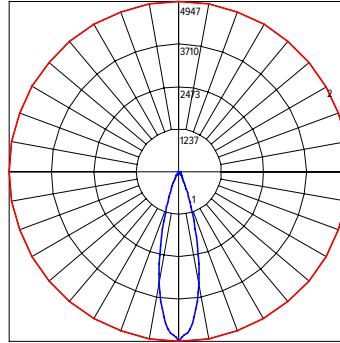

Wide Beam 45° Maximum Candela 2663.88

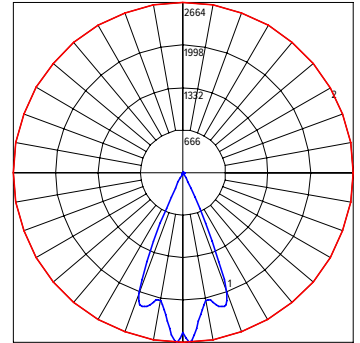

NEUTRAL WHITE

Spot 6° Maximum Candela 86166.59

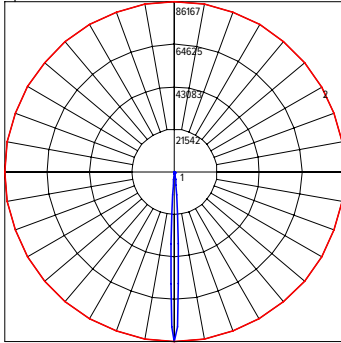

Narrow 18° Maximum Candela 7677.57

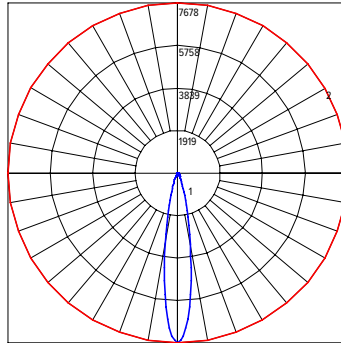

Medium 26° Maximum Candela 5435.76

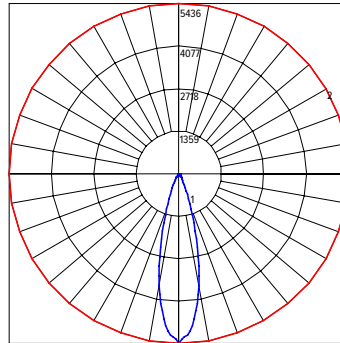

Wide 45° Maximum Candela 2927.26

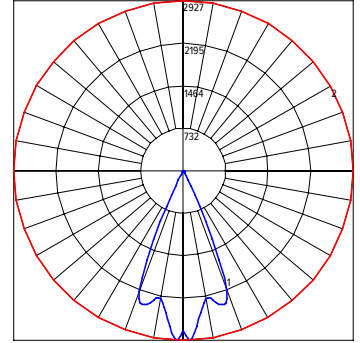



Anthracite Gray _ RGBW



Black _ RGBW



Griven Silver Grey _ RGBW



White _ RGBW



Anthracite Gray _ Dynamic White



Black _ Dynamic White



Griven Silver Grey _ Dynamic White



White _ Dynamic White



Anthracite Gray _ Warm White



Black _ Warm White



Griven Silver Grey _ Warm White



White _ Warm White



Anthracite Gray _ Neutral White



Black _ Neutral White



Griven Silver Grey _ Neutral White



White _ Neutral White



Anthracite Gray _ Cool White



Black _ Cool White



Griven Silver Grey _ Cool White



White _ Cool White