

# RUBY R

Dynamic and Static White



## DESCRIPTION

RUBY R recessed in grade luminaire offers diverse options for spotlighting or wall grazing through an extensive collection of symmetric, elliptical, and wall washing optics. It is available in dynamic white, warm white, or cool white. Programming is easily accomplished via a remote infrared controller and will operate in DMX, automatic, or master-satellite modes for expanded versatility. The 11" diameter luminaire has an overall depth of less than six inches, making it suitable for a wide variety of installation conditions for interior or exterior applications. All hardware is stainless steel.



Date: \_\_\_\_\_ Type: \_\_\_\_\_ Catalog Number: \_\_\_\_\_



Project Name: \_\_\_\_\_

## ORDERING INFORMATION

LUMINAIRE				
MODEL	CCT	VOLTAGE	OPTIC	OPTIONS
RB280 -	DW - 2700-6500K	UNV - 100 - 277V	SP - Spot 12°	SD Spreading Diffuser (consult factory)
	CW - 6300K		NB - Narrow 15°	ATS Anti-Slip Treatment
	30K - 3000K		MB - Medium 24°	
	CCW - Custom White		WB - Wide 47°	
			EW - Extra Wide 58°	
			ELH - Elliptical Horizontal 40° x 14°	
			ELV - Elliptical Vertical 40° x 14°	
			ELWH - Elliptical Wide Horizontal 38° x 23°	
			ELWV - Elliptical Wide Vertical 38° x 23°	
			WW - Wall Wash/Asymmetric	

IP66 / IK09 / CE / <sub>us</sub>

## PRODUCT SPECIFICATIONS

Lumen Output	3666 lumens @ 12° CW (see pg 4 for output values of all standard colors)
Efficacy	99 (lm/W) CW
Lumen Maintenance	100,000 hours L70 @ 25°C*
Color	DW (2700-6500K), CW (6300K), 30K (3000K) (see pg 5 for customization options)
Optics	12°, 15°, 24°, 47°, 58°, 40° x 14°, 38° x 23°, Wall Wash (Additional optics available upon request)
Operating Temperature	-40° to 122° F (-40° to 50°C)
Housing	Die-cast aluminum body with powder coat
Mounting	In-grade
Weight	10.1 lbs. (4.6 kg)
Certification	 
Ingress Protection	Wet location rated IP66
Impact Rating	IK09
Control	Auto Control, DMX 512 (RDM E1.20), Wireless and 0-10V interfaces available
Cable Lengths	DMX: 39.4 inches
Additional Features	Automatic overtemperature protection / Keypad interface

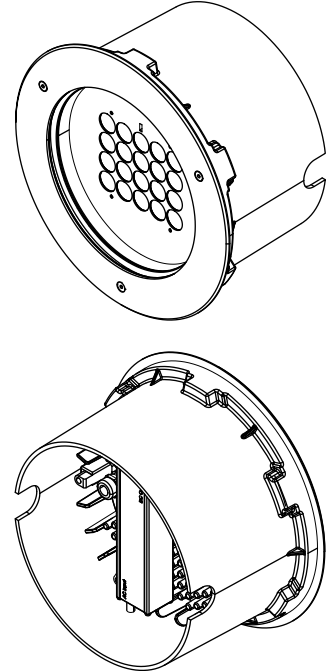

\* LED life may vary under actual field conditions due to external factors. Lifetime estimates are generated from actual testing in a controlled environment. Given values are conservatively derived from those numbers.

## ELECTRICAL SPECIFICATIONS

Input Voltage	100-277 VAC @ 50-60Hz
Power Consumption	37W .32A @ 115VAC, .14A @ 277VAC (RGBW)
Power Factor	>.98 @ 115VAC, >.92 @ 277VAC

# RUBY R

Dynamic and Static White



## DIMENSIONS

All dimensions are shown in inches unless otherwise noted.

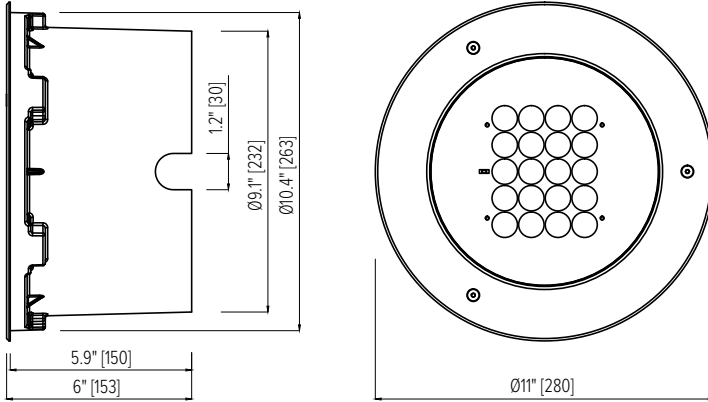

## OPTIC ORIENTATION (For Elliptical Beams)

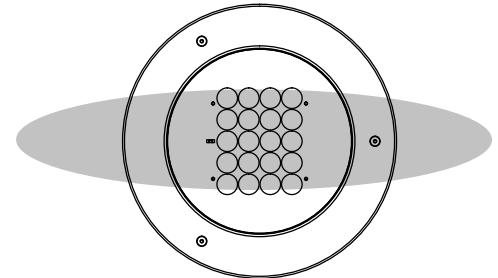

HORIZONTAL MODE (Standard)

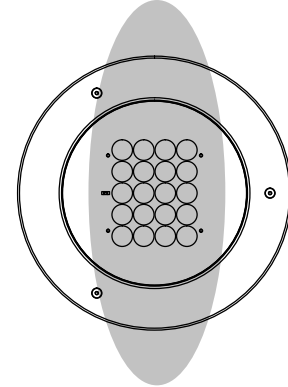

VERTICAL MODE (On Request)

### PHOTOMETRICS

#### LIGHT OUTPUT

Photometric data based on cool white LEDs. Use multiplier to determine lumen and CBCP output for RGBW, DW, or WW.

COLOR	OUTPUT MULTIPLIER
DW (2700-6500K)	.97
CW (6300K)	1.00
WW (3000K)	.94

#### CANDELA DISTRIBUTION (Optical data not currently available for Wall Wash optic)

SPOT (CW) 12°

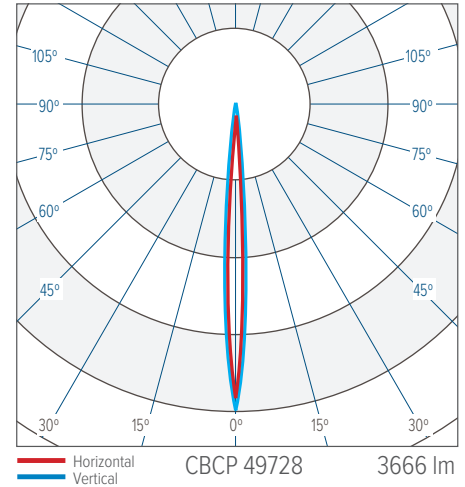

NARROW (CW) 15°

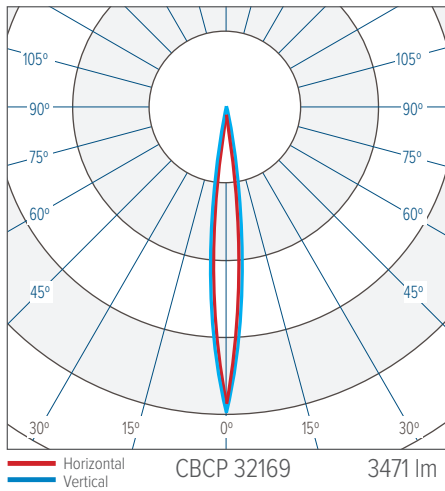

MEDIUM (CW) 24°

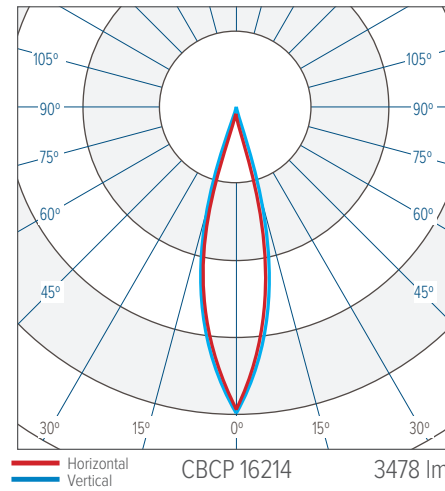

WIDE (CW) 47°

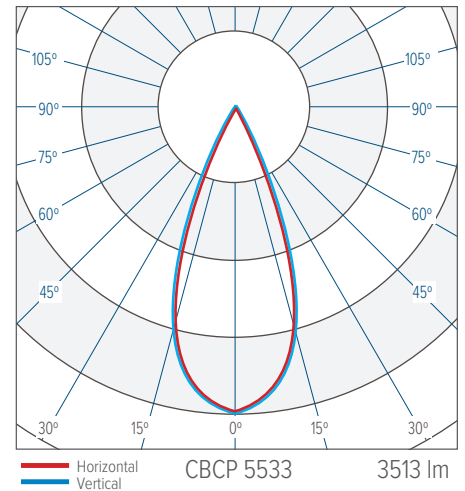

EXTRA WIDE (CW) 58°

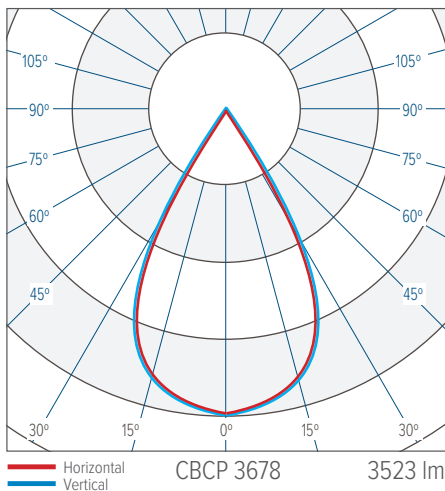

ELLIPTICAL (CW) 40° x 14°

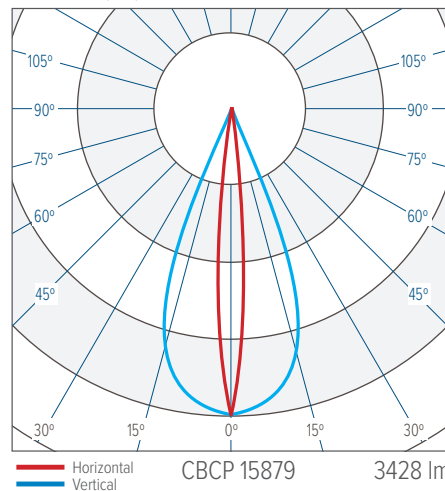

ELLIPTICAL WIDE (CW) 38° x 23°

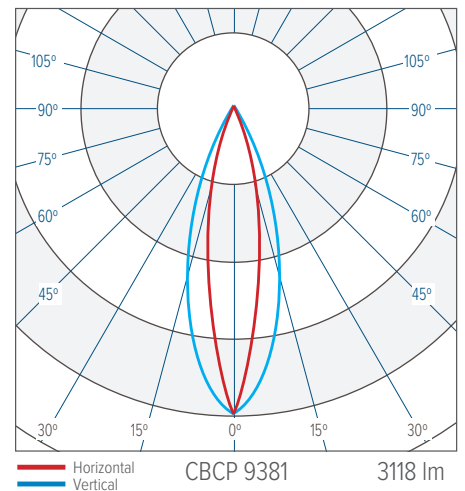

### CONTROL OPTIONS (DMX512, PRIMARY CONTROL PLATFORM)

Contact manufacturer for control system development.

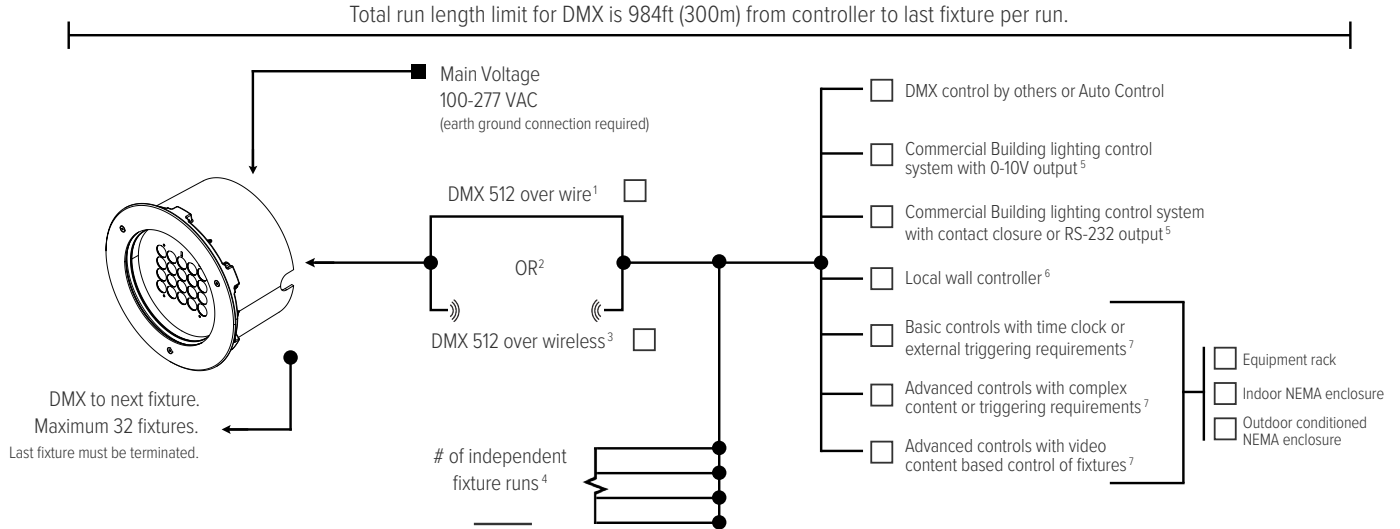

#### Notes

1. Wire specifications are available from factory as well as approved wire for purchase.
2. Other control protocol solutions available. Contact factory for more information.
3. Wireless components are external to fixture. Distance limitations based on antennas chosen and site conditions. Contact factory for more information.
4. Based on maximum of 32 fixtures per run as well as any site constraints on conveyance of data.
5. For example: Lutron, Crestron, Encelium, Douglas, ETC by others. Griven control system will interface with building lighting control system.
6. Local wall controller for small applications. Wall controllers specified separately for larger systems.
7. Contact factory for assistance with specification. Onsite commissioning by Griven of control system is required.

### PRODUCT OPTIONS



#### SPREADING DIFFUSER

Die cut spreading diffusers can be added to fixture. Factory sealed in fixture for highest performance and durability. Consult factory.



#### CUSTOM WHITE LIGHT

Choose the white light you need for your project. Contact Griven USA to confirm availability of a custom CCT.