

PROJECT	TYPE
SPECIFIER	DATE
ORDER #	QTY

PARADE S is a versatile high flux, high luminance light bar featuring RGBW or dynamic white LEDs grouped in clusters of 4 LEDs each. The luminaire is available in three lengths and delivers industry leading light output with uniform color coverage even on close-up installations when using elliptical or elliptical wide optics designed specifically for true wall washing effects. The combination of RGBW LEDs offers unprecedented white light output quality, as well as a wide variety of intermediate color hues for a broad range of applications. The dynamic white model displays brilliant warm tones, natural hues, and cool shades across the white light chromatic scale. Adjustable brackets allow the luminaire to be ground mounted, or installed in any position and orientation on building surfaces for maximum versatility. The lightweight unit features an integral power supply within its narrow profile, eliminating the need for additional electrical hardware. Programming options include stand-alone operation, master-satellite configurations, or operation with a remote DMX512 controller. All hardware is stainless steel.

## PRODUCT SPECIFICATIONS

LUMEN OUTPUT	3934 lumens @ 39"x27" CW Parade S 60 (see pg 3 for output values of all standard colors)
EFFICACY	53 (lm/W) CW
LUMEN MAINTENANCE	100,000 hours L70 @ 25°C*
COLOR	RGBW (6500K white), DW (2700-6500K), CW (6300K), WW (3000K) (see pg 4 for customization options)
OPTICS	39" x 27", 45", 55" x 15", 109" x 37", Wall Wash (Additional optics available upon request)
OPERATING TEMPERATURE	-40° to 122° F (-40° to 50° C)
HOUSING	Extruded aluminum body with powder coat
MOUNTING	Bracket mount with locking hinge (custom mounting available upon request)
WEIGHT	S 60: 13.2 lbs. (6 kg) / S 40: 9.9 lbs. (4.5 kg) / S 20: 5.9 lbs. (2.7 kg)
CERTIFICATION	
INGRESS PROTECTION	Wet location rated IP67
IMPACT RATING	IK09 Parade S 20 / IK08 Parade S 40/60
VIBRATION RATING	ANSI C136.31 rated version available
CONTROL	Auto Control, DMX 512 (RDM E1.20), Wireless and 0-10V interfaces available
ADDITIONAL FEATURES	Automatic overtemperature protection / IR Remote

\* LED life may vary under actual field conditions due to external factors. Lifetime estimates are generated from actual testing in a controlled environment, Griven values are conservatively derived from those numbers.

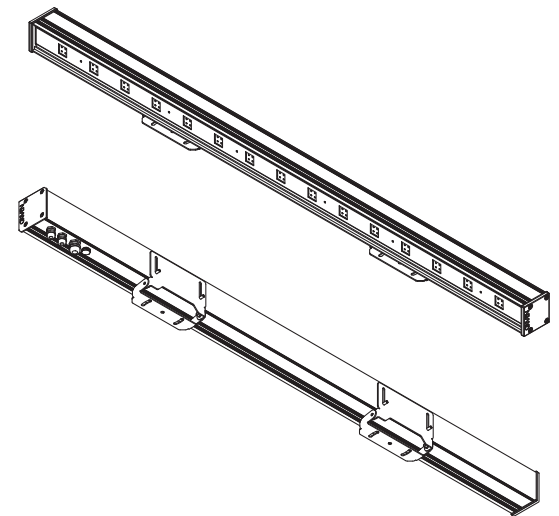

## ELECTRICAL SPECIFICATIONS

INPUT VOLTAGE	100-277 VAC @ 50-60Hz
POWER CONSUMPTION	74W 0.63A @ 115VAC, 0.29A @ 277VAC 49W 0.41A @ 115VAC, 0.2A @ 277VAC 28W 0.21A @ 115VAC, 0.11A @ 277VAC
POWER FACTOR	S 20/S 40: >.98 @ 115VAC, >.92 @ 277VAC S 60: >.9 @ 115VAC, >.9 @ 277VAC
PROTECTION	Self-resetting fuse

IP67 / IK08-IK09 /  / 

## HOW TO ORDER

PART	COLOR	VOLTAGE	OPTIC	ORIENTATION*	FINISH	ACCESSORIES	OPTIONS
PDS60 Parade S 60	RGBW	UNV 100-277V	MB Medium 39° x 27°	H Horizontal	SG Silver Gray	BND Barndoor	SD Spreading Diffuser (consult factory)
PDS40 Parade S 40	DW 2700-6500K		WB Wide 45°	V Vertical	CC Custom Color	FGS Full Glare Shield	3G ANSI C136.31 Vibration Rating
PDS20 Parade S 20	CW 6300K		ELLB* Elliptical 55° x 15°		SGM Silver Gray Marine Grade	AGS Angled Glare Shield	
	WW 3000K		ELWB* Elliptical Wide 109° x 37°		CCMG Custom Color Marine Grade	LVR Louver	
	CCW Custom White		WW Wall Wash				
	CCM Custom Monochrome						

\* Specify horizontal or vertical orientation

## DIMENSIONAL DRAWINGS

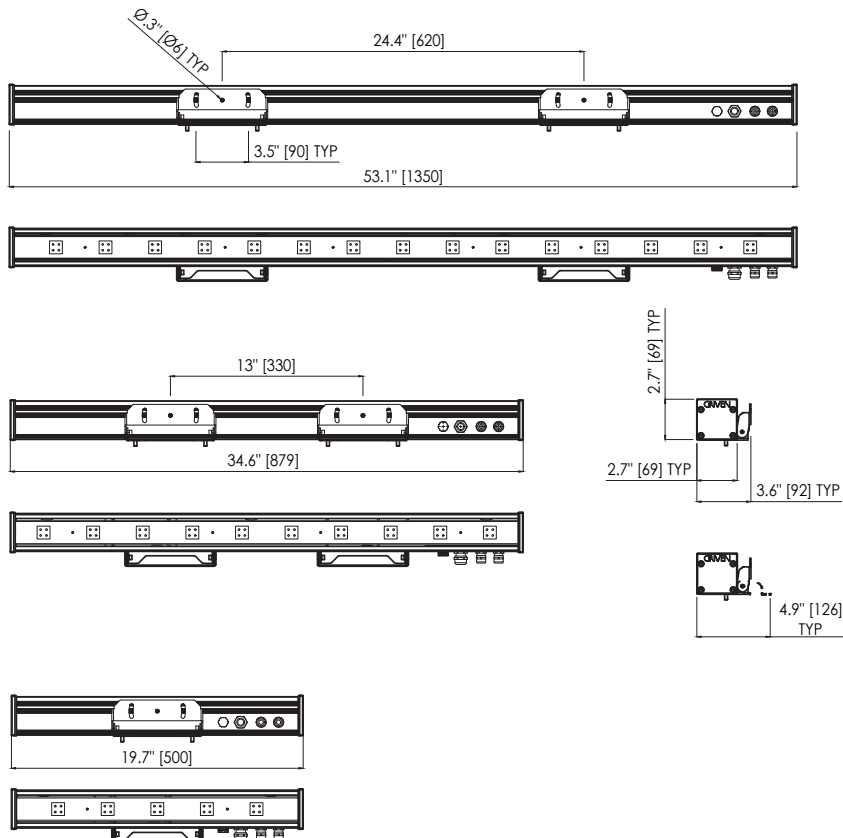

## OPTIC ORIENTATION (For Elliptical Beams)

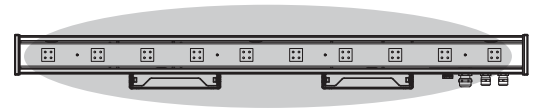

HORIZONTAL MODE (Standard)

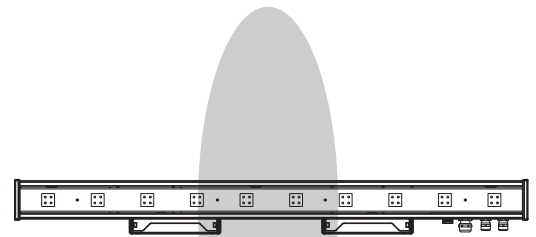

VERTICAL MODE (On Request)

## PHOTOMETRICS

### LIGHT OUTPUT

Photometric data based on cool white LEDs. Use multiplier to determine lumen and CBCP output for RGBW, DW, or WW.

COLOR	OUTPUT MULTIPLIER
RGBW (6500K White)	.63
DW (2700-6500K)	.85
CW (6300K)	1.00
WW (3000K)	.70

### CANDELA DISTRIBUTION

MEDIUM (CW) 39° x 27°

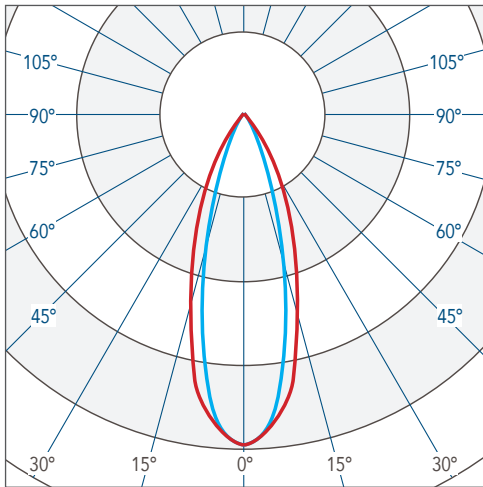

Horizontal Vertical	<b>S 60 CBCP 9322</b> <b>3934 lm</b>
	<b>S 40 CBCP 6346</b> <b>2648 lm</b>
	<b>S 20 CBCP 2993</b> <b>1333 lm</b>

WIDE (CW) 45°

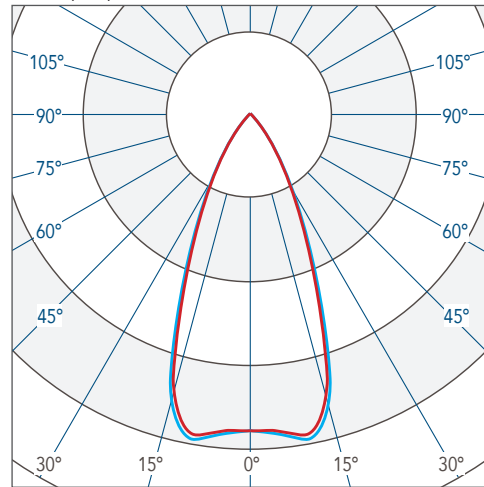

Horizontal Vertical	<b>S 60 CBCP 5935</b> <b>3705 lm</b>
	<b>S 40 CBCP 4044</b> <b>2500 lm</b>
	<b>S 20 CBCP 1973</b> <b>1234 lm</b>

ELLIPTICAL (CW) 55° x 14°

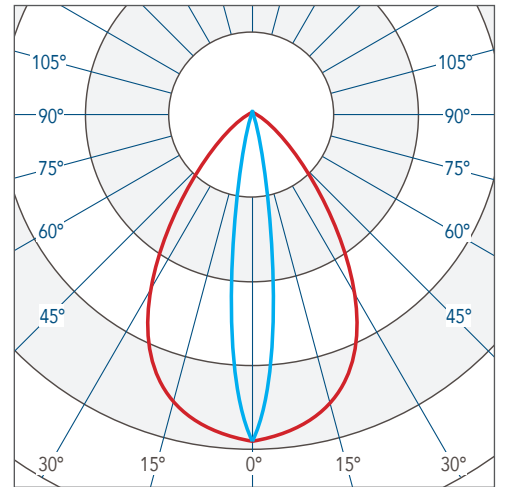

Horizontal Vertical	<b>S 60 CBCP 11717</b> <b>3662 lm</b>
	<b>S 40 CBCP 7204</b> <b>2458 lm</b>
	<b>S 20 CBCP 3628</b> <b>1249 lm</b>

ELLIPTICAL WIDE (CW) 109° x 37°

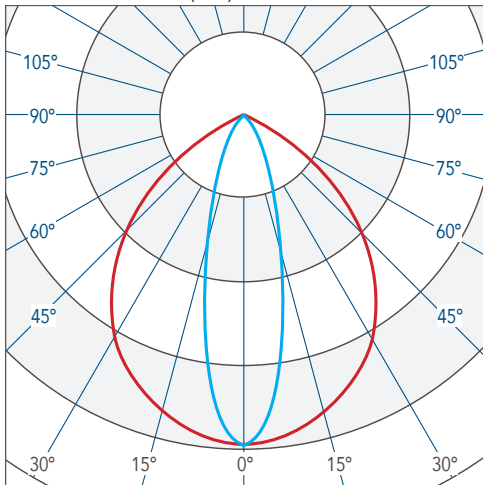

Horizontal Vertical	<b>S 60 CBCP 3042</b> <b>3594 lm</b>
	<b>S 40 CBCP 2046</b> <b>2436 lm</b>
	<b>S 20 CBCP 1006</b> <b>1234 lm</b>

WALL WASH (CW)

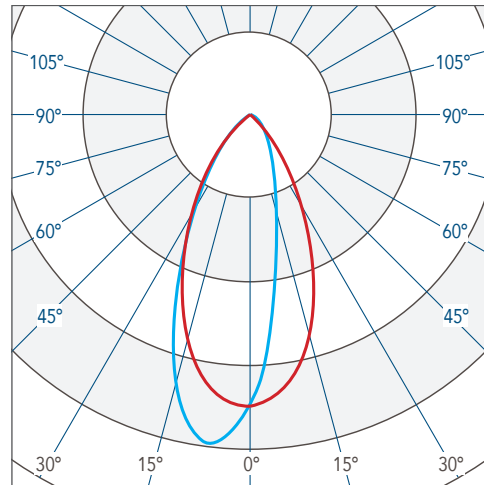

Horizontal Vertical	<b>S 60 CBCP 9622</b> <b>3695 lm</b>
	<b>S 40 CBCP 6509</b> <b>2471 lm</b>
	<b>S 20 CBCP 3299</b> <b>1239 lm</b>



## CONTROL OPTIONS (DMX512, PRIMARY CONTROL PLATFORM)

Contact manufacturer for control system development.

Total run length limit for DMX is 984ft (300m) from controller to last fixture per run.

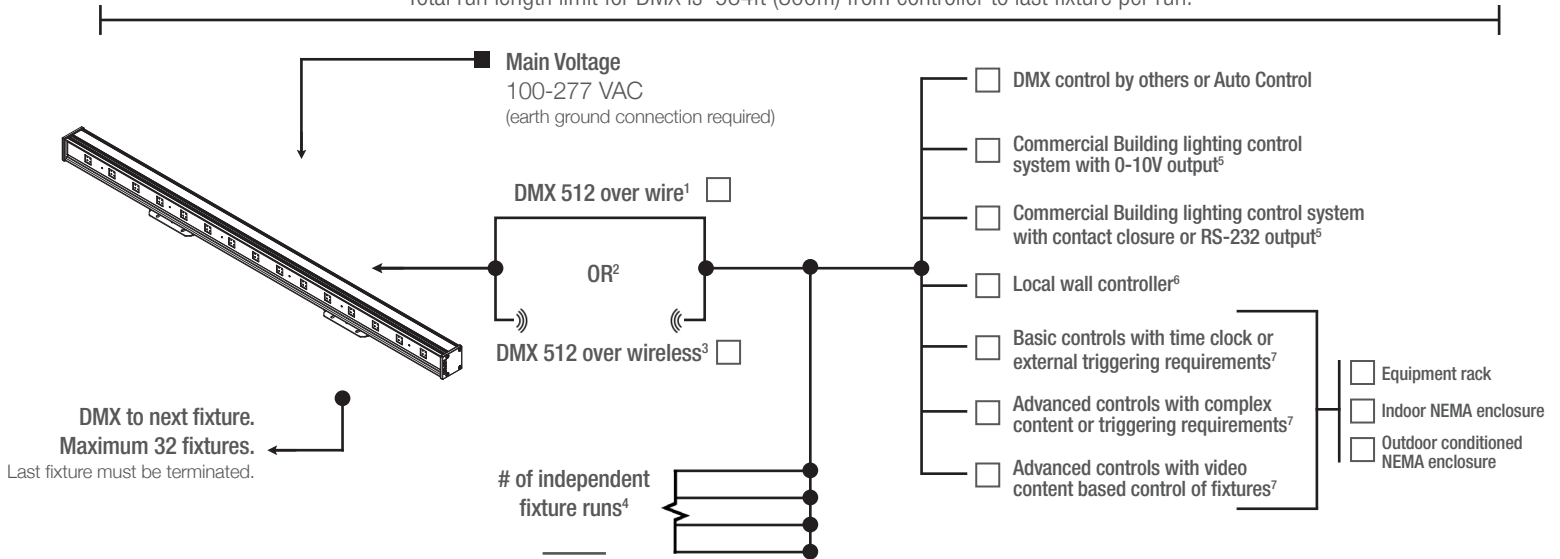

### NOTES

1. Wire specifications are available from factory as well as approved wire for purchase.
2. Other control protocol solutions available. Contact factory for more information.
3. Wireless components are external to fixture. Distance limitations based on antennas chosen and site conditions. Contact factory for more information.
4. Based on maximum of 32 fixtures per run as well as any site constraints on conveyance of data.
5. For example: Lutron, Crestron, Encelium, Douglas, ETC by others. Griven control system will interface with building lighting control system.
6. Local wall controller for small applications. Wall controllers specified separately for larger systems.
7. Contact factory for assistance with specification. Onsite commissioning by Griven of control system is required.

## PRODUCT OPTIONS



### SPREADING DIFFUSER

Die cut spreading diffusers can be added to fixture. Factory sealed in fixture for highest performance and durability. Consult factory.



### MARINE GRADE COATING

Maximum corrosion resistance for installations near salt or brackish water.



### CUSTOM WHITE LIGHT

Choose the white light you need for your project. Contact Griven USA to confirm availability of a custom CCT.



### CUSTOM MONOCHROME

Fixtures with dedicated color LEDs available. Contact Griven USA to confirm availability of a custom color.

## ACCESSORIES

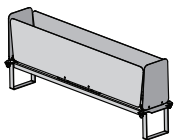

Bardoor

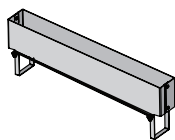

Full Glare Shield

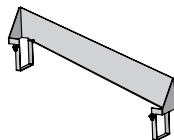

Angled Glare Shield

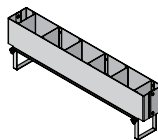

Louver

