

PROJECT	TYPE
SPECIFIER	DATE
ORDER #	QTY

POWERSHINE MK2 S sets the benchmark for illumination of large scale architectural structures and associated applications where high impact lighting is required. With an industry leading high lumen package, the luminaire effectively achieves desired lighting goals and simplifies installations using fewer units. Smartly combined with a versatile selection of seven distinctive light distributions, POWERSHINE MK2 S satisfies lighting tasks ranging from simple façade lighting to the illumination of objects from long distances. The projector incorporates 96 high power LEDs in a choice of dynamic white, warm white, or cool white, providing an extensive palette of tones and hues to choose from. Design features include a thermally isolated LED driver compartment and on-board controls, allowing users to integrate a DMX control system for dynamic color-changing scenes, displaying fixed colors, or sequencing colors without DMX when using the integrated automatic control mode. All hardware is stainless steel.

PRODUCT SPECIFICATIONS

LUMEN OUTPUT	30003 lumens @ 12° CW (see pg 3 for output values of all standard colors)
EFFICACY	101.4 (lm/W) CW
LUMEN MAINTENANCE	100,000 hours L70 @ 25°C*
COLOR	DW (2700-6500K), CW (6300K), WW (3000K) (see pg 4 for customization options)
OPTICS	12°, 15°, 24°, 44°, 59°, 40°x14°, 37°x23°
OPERATING TEMPERATURE	-40° to 122° F (-40° to 50° C)
HOUSING	Die-cast aluminum body with powder coat
MOUNTING	Yoke mount with locking hinge (custom mounting available upon request)
WEIGHT	41 lbs. (20 kg)
CERTIFICATION	
INGRESS PROTECTION	Wet location rated IP66
IMPACT RATING	IK10
VIBRATION RATING	ANSI C136.31 rated version available
CONTROL	Auto Control, DMX 512 (RDM E1.20), Wireless and 0-10V interfaces available
ADDITIONAL FEATURES	Automatic overtemperature protection / Keypad interface
EPA	2.27 ft²

* LED life may vary under actual field conditions due to external factors. Lifetime estimates are generated from actual testing in a controlled environment, Griven values are conservatively derived from those numbers.

ELECTRICAL SPECIFICATIONS

INPUT VOLTAGE	100-277 VAC @ 50-60Hz
POWER CONSUMPTION	296W 2.98A @ 115VAC, 1.09A @ 277VAC
POWER FACTOR	>.98 @ 115VAC, >.94 @ 277VAC
PROTECTION	Self-resetting fuse

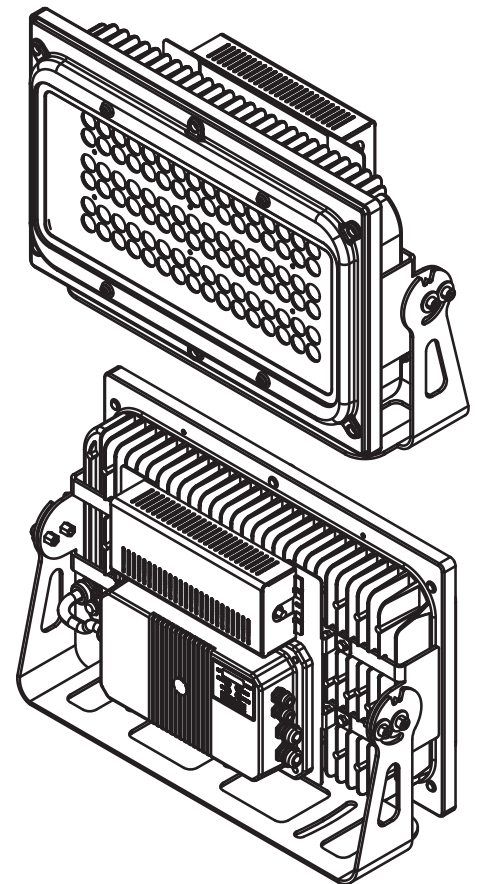

IP66 / IK10 / CE / 

HOW TO ORDER

PS546		UNV		(leave blank if symmetric)			
PART	COLOR	VOLTAGE	OPTIC	ORIENTATION*	FINISH	ACCESSORIES	OPTIONS
	DW 2700-6500K	UNV 100-277V	SP Spot 12°	H Horizontal	SG Silver Gray	BND Barndoor	SD Spreading Diffuser (consult factory)
	CW 6300K		NB Narrow 15°	V Vertical	CC Custom Color	FGS Full Glare Shield	3G ANSI C136.31 Vibration Rating
	WW 3000K		MB Medium 24°		SGM Silver Gray Marine Grade	AGS Angled Glare Shield	
	CCW Custom White		WB Wide 44°		CCMG Custom Color Marine Grade		
			EXWB Extra Wide 59°				
			ELLB* Elliptical 40° x 14°				
			ELWB* Elliptical Wide 37° x 23°				

* Specify horizontal or vertical orientation

DIMENSIONAL DRAWINGS

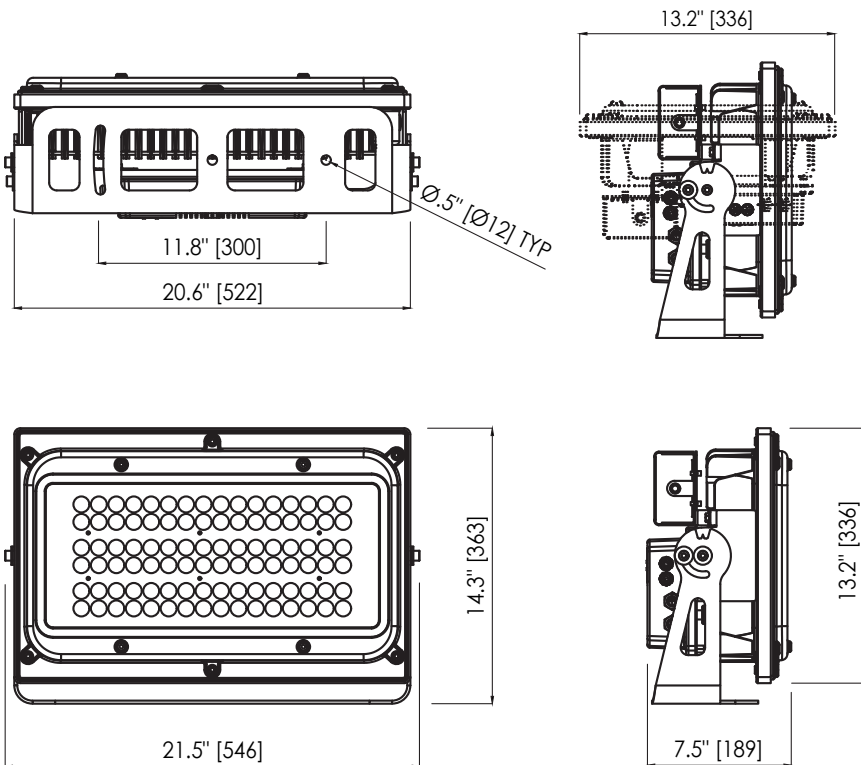

OPTIC ORIENTATION (For Elliptical Beams)

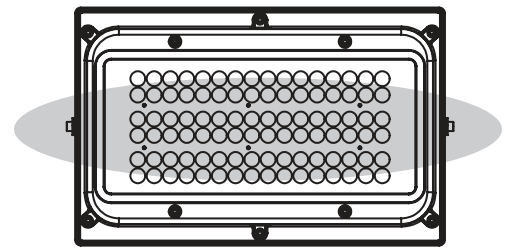

HORIZONTAL MODE (Standard)

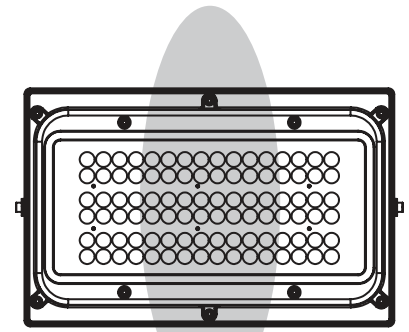

VERTICAL MODE (On Request)

PHOTOMETRICS

LIGHT OUTPUT

Photometric data based on cool white LEDs. Use multiplier to determine lumen and CBCP output for DW or WW.

COLOR	OUTPUT MULTIPLIER
DW (2700-6500K)	.97
CW (6300K)	1.00
WW (3000K)	.94

SPOT (CW) 12°

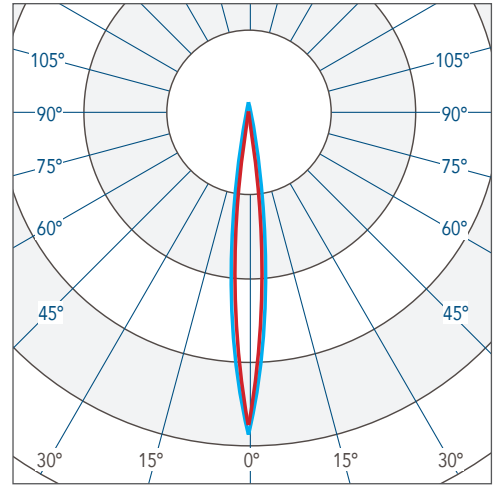

Horizontal Vertical **CBCP 403319 30003 lm**

NARROW (CW) 15°

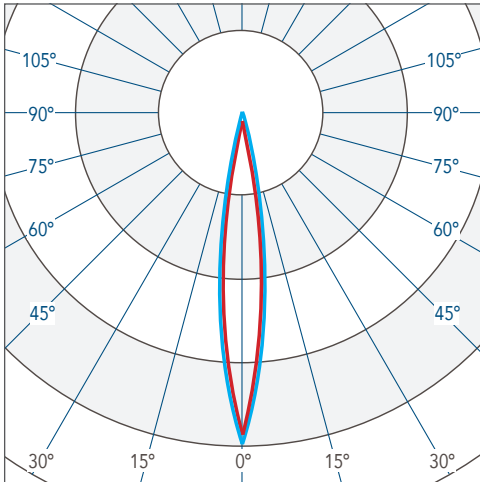

Horizontal Vertical **CBCP 260947 28104 lm**

MEDIUM (CW) 24°

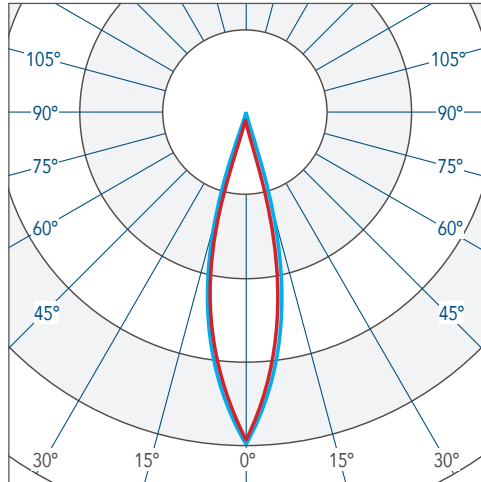

Horizontal Vertical **CBCP 137348 29073 lm**

WIDE (CW) 44°

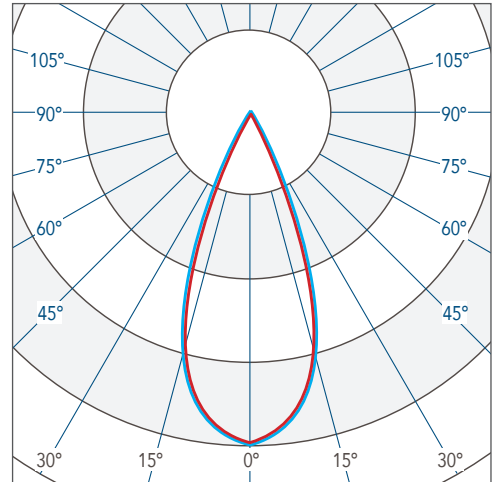

Horizontal Vertical **CBCP 34711 22133 lm**

EXTRA WIDE (CW) 59°

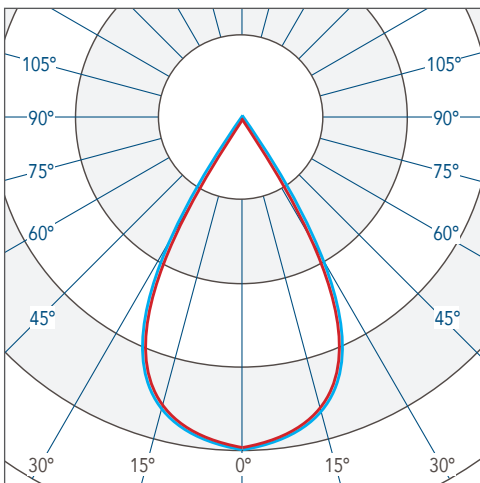

Horizontal Vertical **CBCP 25849 24764 lm**

ELLIPTICAL (CW) 40° x 14°

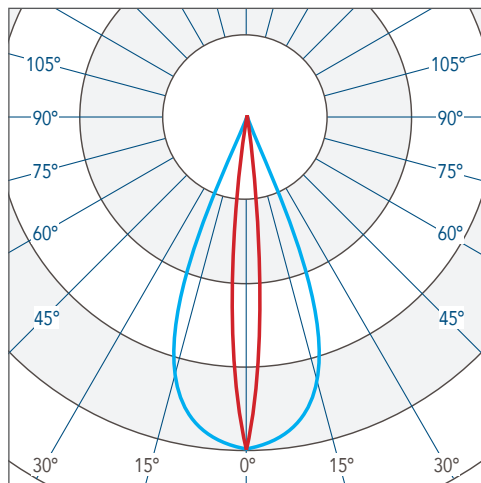

Horizontal Vertical **CBCP 137191 29617 lm**

ELLIPTICAL WIDE (CW) 37° x 23°

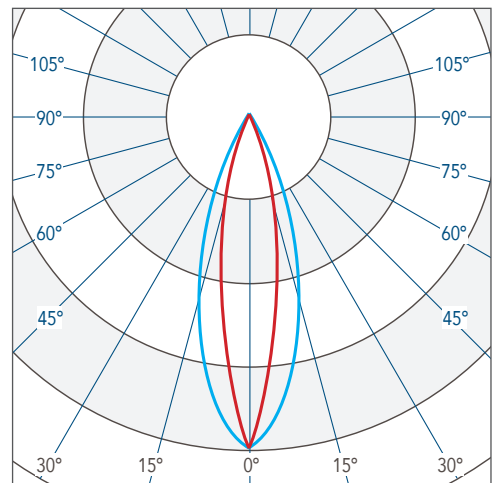

Horizontal Vertical **CBCP 881038 26937 lm**

CONTROL OPTIONS (DMX512, PRIMARY CONTROL PLATFORM)

Contact manufacturer for control system development.

Total run length limit for DMX is 984ft (300m) from controller to last fixture per run.

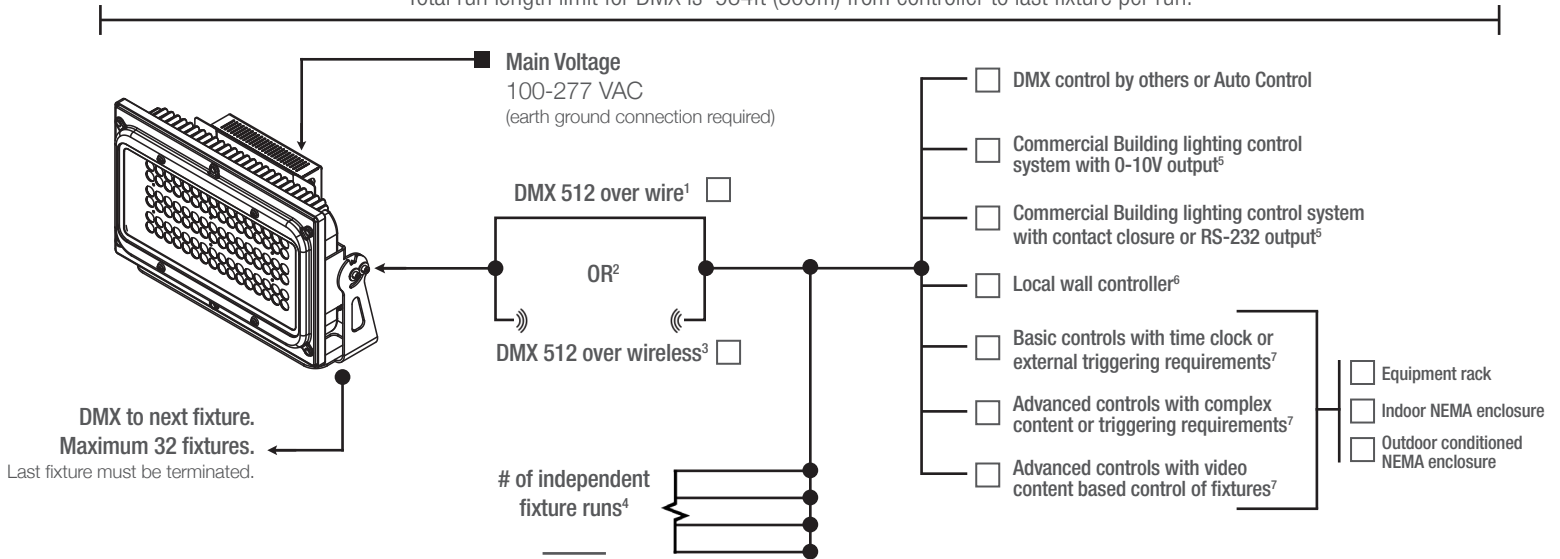

NOTES

1. Wire specifications are available from factory as well as approved wire for purchase.
2. Other control protocol solutions available. Contact factory for more information.
3. Wireless components are external to fixture. Distance limitations based on antennas chosen and site conditions. Contact factory for more information.
4. Based on maximum of 32 fixtures per run as well as any site constraints on conveyance of data.
5. For example: Lutron, Crestron, Encelium, Douglas, ETC by others. Griven control system will interface with building lighting control system.
6. Local wall controller for small applications. Wall controllers specified separately for larger systems.
7. Contact factory for assistance with specification. Onsite commissioning by Griven of control system is required.

PRODUCT OPTIONS



SPREADING DIFFUSER

Die cut spreading diffusers can be added to fixture. Factory sealed in fixture for highest performance and durability. Consult factory.



MARINE GRADE COATING

Maximum corrosion resistance for installations near salt or brackish water.



CUSTOM WHITE LIGHT

Choose the white light you need for your project. Contact Griven USA to confirm availability of a custom CCT.

ACCESSORIES

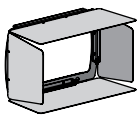

Barndoor

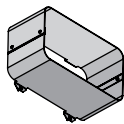

Full Glare Shield

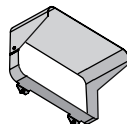

Angled Glare Shield

