

PROJECT	TYPE
SPECIFIER	DATE
ORDER #	QTY

POWERSHINE MK2 S sets the benchmark for illumination of large scale architectural structures and associated applications where high impact lighting is required. With an industry leading high lumen package, the luminaire effectively achieves desired lighting goals and simplifies installations using fewer units. Smartly combined with a versatile selection of seven distinctive light distributions, POWERSHINE MK2 S satisfies lighting tasks ranging from simple façade lighting to the illumination of objects from long distances. The projector incorporates 96 high power LEDs in RGBW, providing an extensive palette of colors to choose from. Design features include a thermally isolated LED driver compartment and on-board controls, allowing users to integrate a DMX control system for dynamic color-changing scenes, displaying fixed colors, or sequencing colors without DMX when using the integrated automatic control mode. All hardware is stainless steel.

## PRODUCT SPECIFICATIONS

LUMEN OUTPUT	9644 lumens @ 8° RGBW (see pg 3 for output values of all standard colors)
EFFICACY	32.6 (lm/W) RGBW
LUMEN MAINTENANCE	100,000 hours L70 @ 25°C*
COLOR	RGBW (6500K white) (see pg 4 for customization options)
OPTICS	8°, 12°, 23°, 43°, 68°, 41° x 11°, 39° x 22°
OPERATING TEMPERATURE	-40° to 122° F (-40° to 50° C)
HOUSING	Die-cast aluminum body with powder coat
MOUNTING	Yoke mount with locking hinge (custom mounting available upon request)
WEIGHT	41 lbs. (20 kg)
CERTIFICATION	
INGRESS PROTECTION	Wet location rated IP66
IMPACT RATING	IK10
VIBRATION RATING	ANSI C136.31 rated version available
CONTROL	Auto Control, DMX 512 (RDM E1.20), Wireless and 0-10V interfaces available
ADDITIONAL FEATURES	Automatic overtemperature protection / Keypad interface
EPA	2.27 ft²

\* LED life may vary under actual field conditions due to external factors. Lifetime estimates are generated from actual testing in a controlled environment, Griven values are conservatively derived from those numbers.

## ELECTRICAL SPECIFICATIONS

INPUT VOLTAGE	100-277 VAC @ 50-60Hz
POWER CONSUMPTION	296W 2.98A @ 115VAC, 1.09A @ 277VAC
POWER FACTOR	>.98 @ 115VAC, >.94 @ 277VAC
PROTECTION	Self-resetting fuse

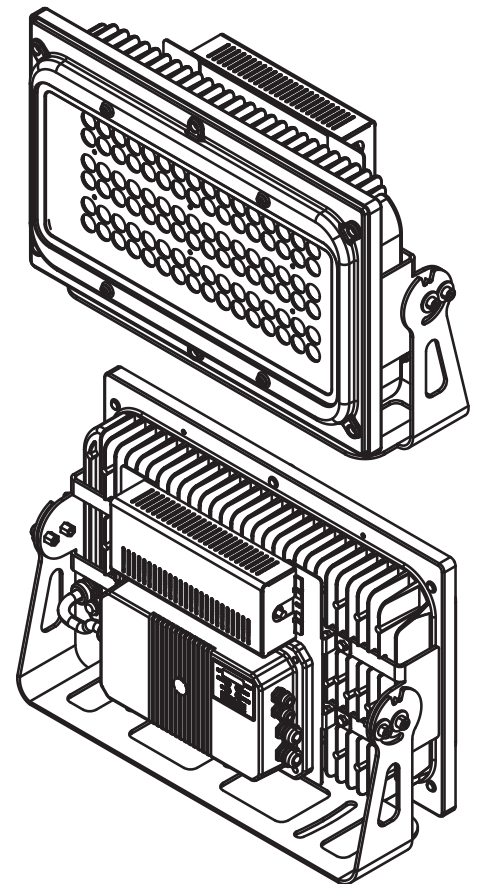

IP66 / IK10 / CE / 

## HOW TO ORDER

PS546	COLOR	UNV	OPTIC	ORIENTATION*	FINISH	ACCESSORIES	OPTIONS
PART	RGBW	VOLTAGE	SP Spot 8°	(leave blank if symmetric) H Horizontal	SG Silver Gray	FGS Full Glare Shield	SD Spreading Diffuser (consult factory)
	CCM Custom Monochrome	UNV 100-277V	NB Narrow 12°	V Vertical	CC Custom Color	AGS Angled Glare Shield	3G ANSI C136.31 Vibration Rating
			MB Medium 23°		SGM Silver Gray Marine Grade		
			WB Wide 43°		CCMG Custom Color Marine Grade		
			EXWB Extra Wide 68°				
			ELLB* Elliptical 41° x 11°				
			ELWB* Elliptical Wide 39° x 22°				

\* Specify horizontal or vertical orientation

## DIMENSIONAL DRAWINGS

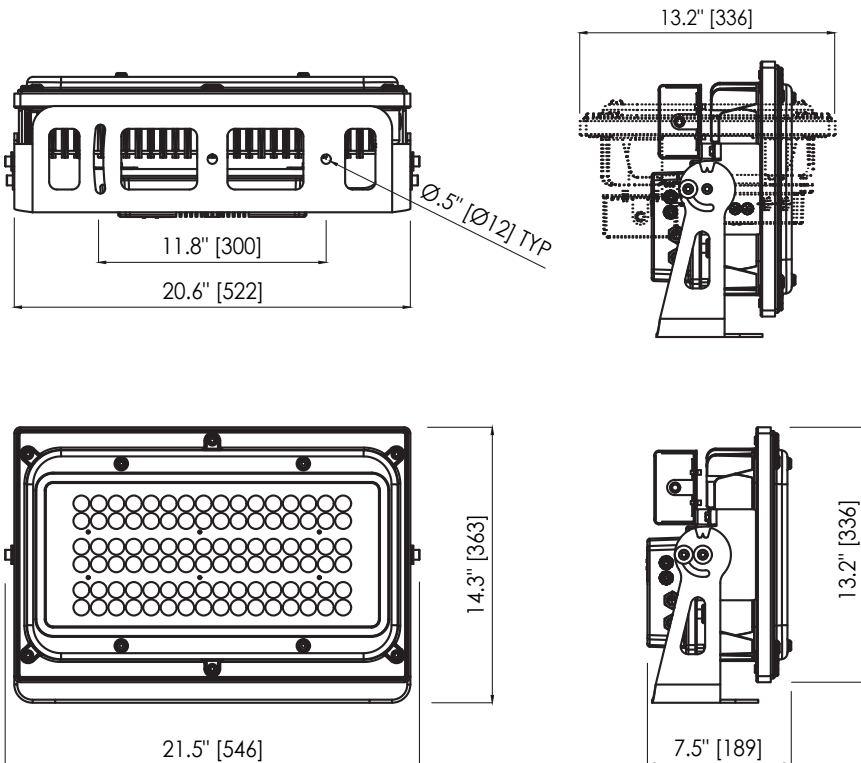

## OPTIC ORIENTATION (For Elliptical Beams)

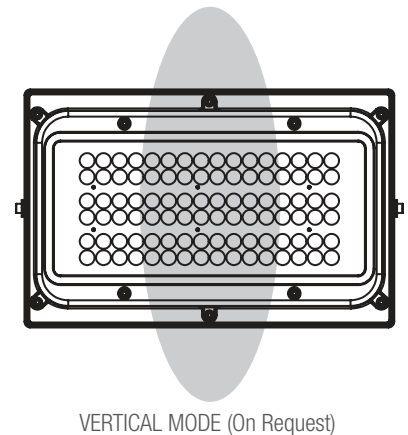
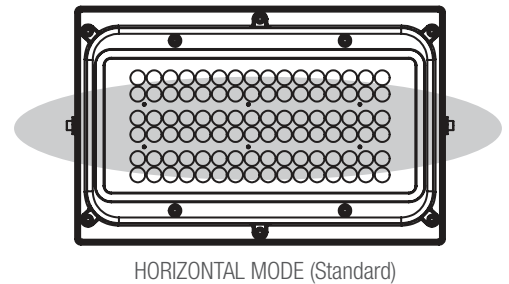

## PHOTOMETRICS

CANDELA DISTRIBUTION (Optical data not currently available for Extra Wide 68° optic.)

SPOT (RGBW) 8°

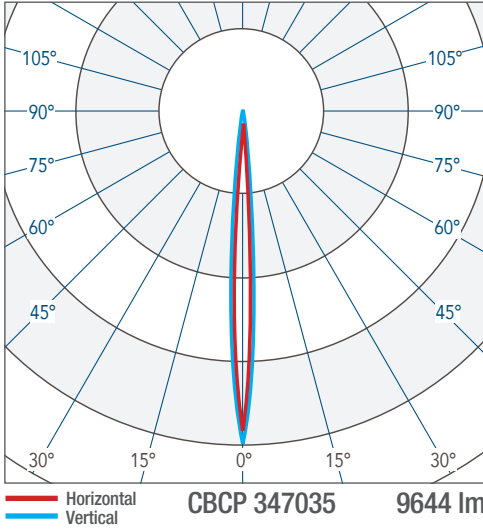

NARROW (RGBW) 12°

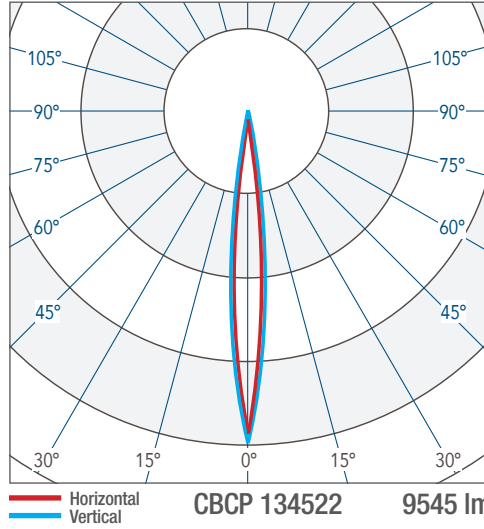

MEDIUM (RGBW) 23°

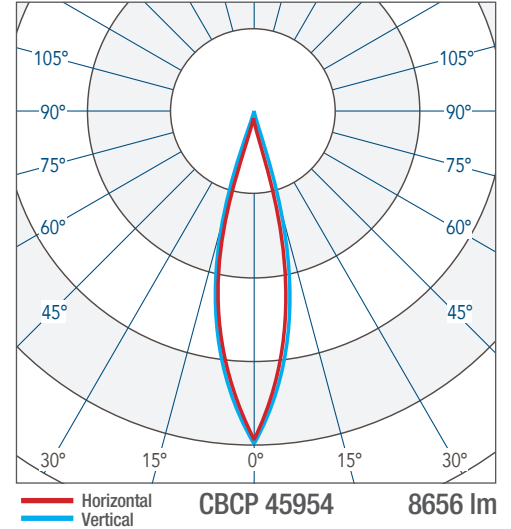

WIDE (RGBW) 43°

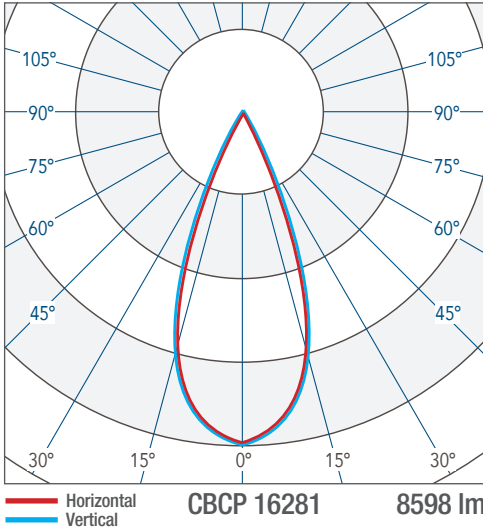

ELLIPTICAL (RGBW) 41° x 11°

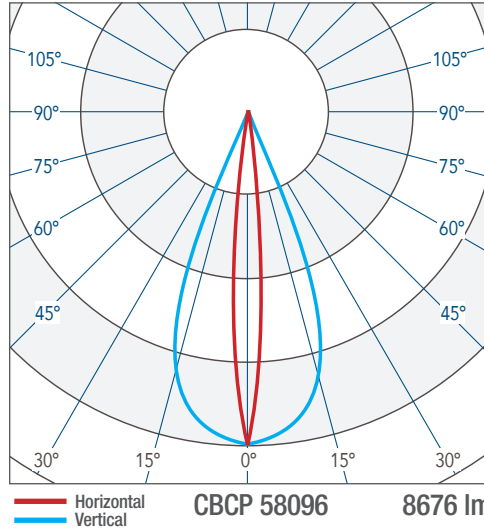

ELLIPTICAL WIDE (RGBW) 39° x 22°

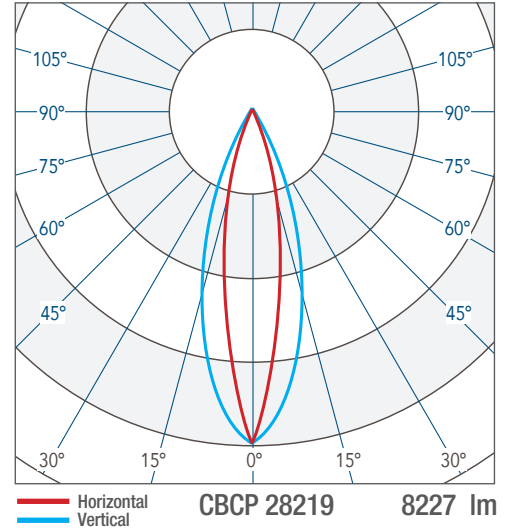

## CONTROL OPTIONS (DMX512, PRIMARY CONTROL PLATFORM)

Contact manufacturer for control system development.

Total run length limit for DMX is 984ft (300m) from controller to last fixture per run.

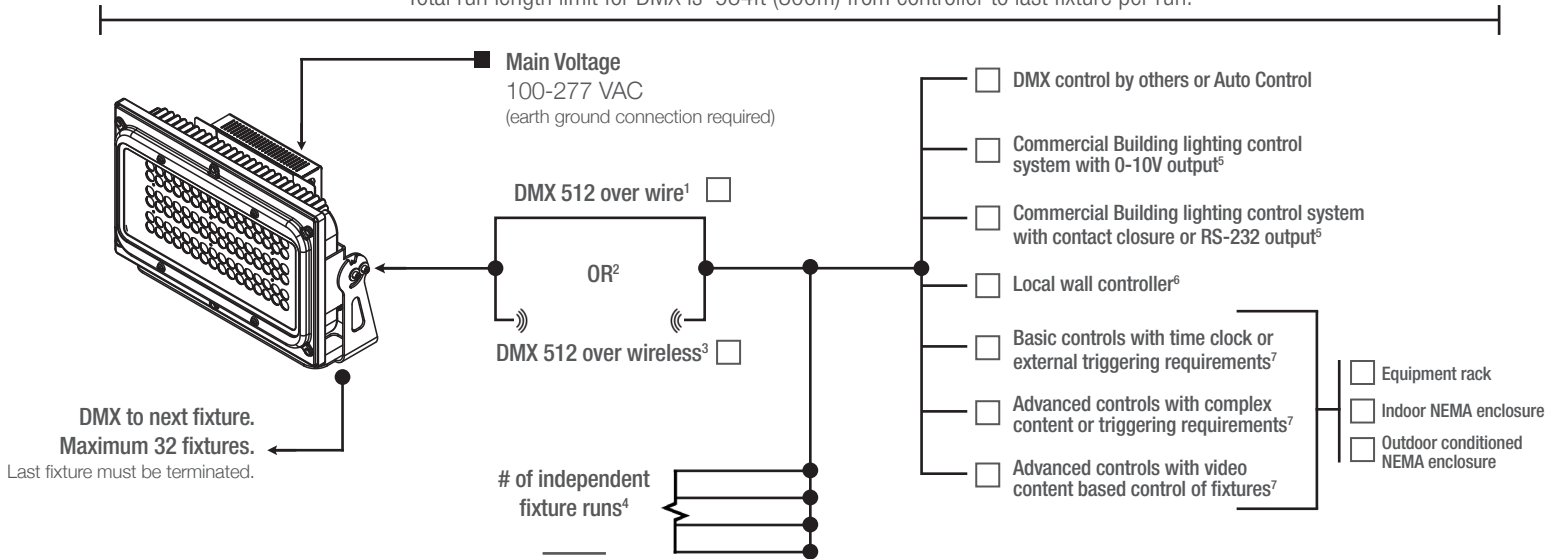

### NOTES

1. Wire specifications are available from factory as well as approved wire for purchase.
2. Other control protocol solutions available. Contact factory for more information.
3. Wireless components are external to fixture. Distance limitations based on antennas chosen and site conditions. Contact factory for more information.
4. Based on maximum of 32 fixtures per run as well as any site constraints on conveyance of data.
5. For example: Lutron, Crestron, Encelium, Douglas, ETC by others. Griven control system will interface with building lighting control system.
6. Local wall controller for small applications. Wall controllers specified separately for larger systems.
7. Contact factory for assistance with specification. Onsite commissioning by Griven of control system is required.

## PRODUCT OPTIONS



### SPREADING DIFFUSER

Die cut spreading diffusers can be added to fixture. Factory sealed in fixture for highest performance and durability. Consult factory.



### MARINE GRADE COATING

Maximum corrosion resistance for installations near salt or brackish water.



### CUSTOM MONOCHROME

Fixtures with dedicated color LEDs available. Contact Griven USA to confirm availability of a custom color.

## ACCESSORIES

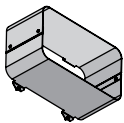

Full Glare Shield

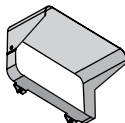

Angled Glare Shield

